



293

**Digital Clamp-on
Meter *Amp Plus*
Instruction Manual**

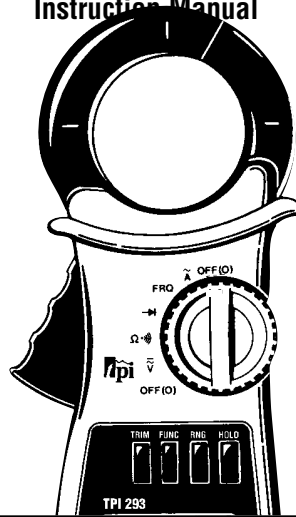

TABLE OF CONTENTS

A. INTRODUCTION	
1. Congratulations	3
2. Product Description	3
3. Declaration of Conformity	4
B. SAFETY CONSIDERATIONS	5
C. TECHNICAL DATA	
1. Features and Benefits.....	7
2. Product Applications	8
3. Specifications.....	9
D. MEASUREMENT TECHNIQUES	
1. Controls and Functions	12
2. Step by Step Procedures:	15
E. ACCESSORIES	26
F. MAINTENANCE	27
G. TROUBLE SHOOTING GUIDE	28

A. INTRODUCTION

1. Congratulations!!

Thank you for purchasing TPI products. The *Amp Plus* is easy to use and is built to last. It is backed by a 3 year limited warranty. Please remember to complete and return your product warranty registration card.

2. Product Description

The 293 is a clamp-on plus DMM with True RMS capabilities. The 293 offers measurements in all basic electrical functions, plus:

- **True RMS** Provides accurate and dependable readings of non-linear loads.
- **Bar Graph** When measuring frequency, bar graph indicates current level.
- **TRIM Mode** Smooths out unstable readings.
- **Peak Mode** For start-up and inrush currents.
- **Sleep Mode** Preserves battery life.
- **Data Hold** Holds the reading on the display for easy viewing.

The 293 comes complete with the following accessories:

Carrying Pouch
Test Lead Set
Instruction Manual
Battery

3. EC Declaration of Conformity

This is to certify that TPI Model 293 conforms to the protection requirements of the council directive 89/336/EEC, in the approximation of laws of the member states relating to Electromagnetic compatibility and 73/23/EEC. The Low Voltage Directive by application of the following standards:

EN 50081-1	1992 Emissions Standard
EN 50082-1	1992 Immunity Standard
EN 61010-1	1993 Safety Standard
EN 61010-2-031	1995 Safety Standard
EN 61010-2-032	1995 Safety Standard

To ensure conformity with these standard, this instrument must be operated in accordance with the instructions and specifications given in this manual.

CAUTION: *Even though this instrument complies with the immunity standards, it's accuracy can be affected by strong radio emissions not covered in the above standards. Sources such as hand-held radio transceivers, radio and TV transmitters, vehicle radios and cellular phones generate electromagnetic radiation that could be induced into the test leads of this instrument. Care should be taken to avoid such situations or alternatively, check to make sure that the instrument is not being influence by these emissions.*

CAUTION: *Please follow manufacturers test procedures whenever possible. Do not attempt to measure unknown voltages or components until a complete understanding of the circuit is obtained.*

B. SAFETY CONSIDERATIONS

 **WARNING:** *Please follow manufacturers test procedures whenever possible. Do not attempt to measure unknown voltages or components until a complete understanding of the circuit is obtained.*

GENERAL GUIDELINES





ALWAYS

- Test the 293 before using it to make sure it is operating properly.
- Inspect the test leads before using to make sure there are no breaks or shorts.
- Double check all connections before testing.
- Have someone check on you periodically if working alone.
- Have a complete understanding of the circuit being measured.
- Disconnect power to circuit, then connect test leads to the 293, then to circuit being measured.

NEVER

- Attempt to measure unknown high voltages.
- Attempt to measure current with the meter in parallel to the circuit.
- Connect the test leads to a live circuit before setting up the instrument.
- Touch any exposed metal part of the test lead assembly.

INTERNATIONAL SYMBOLS

-  **CAUTION: RISK OF ELECTRIC SHOCK**
-  **REFER TO INSTRUCTION MANUAL**
-  **GROUND**
-  **DOUBLE INSULATION**
-  **EITHER DC OR AC**

C. TECHNICAL DATA

1. Features and Benefits

- Agency** UL Listed to U.S. and Canadian Safety Standards. Meets CE and IEC 1010.
- True RMS** Needed to accurately measure non-sinusoidal AC voltage and current waveforms found on many controls and circuits.
- 4000 Count** Improves the resolution on all functions and ranges.
- Data Hold** Maintains the reading on the display for hard to reads areas.
- Peak Mode** Measure the inrush current of motors, relays and solenoids.
- Trim Mode** Averages the readings for more stable output on LCD.
- Sleep Mode** Automatically powers down after 10 minutes of inactivity.
- Frequency** Measures the frequency of the current being measured.
- Dual Display** When measuring frequency, the bar graph indicates the current level.
- Bar Graph** Shows rapidly changing input signals that the normal display will not.

2. Product Applications

Perform the following tests and/or measurements with the 293 and the appropriate function:

HVAC/R

- ACA** • Heat anticipator current in thermostats.
- ACV** • Line voltage.
- ACV or DCV** • Control circuit voltage.
- OHMS** • Heating element resistance (continuity).
- OHMS** • Compressor winding resistance.
- OHMS** • Contactor and relay coil resistance.
- ACA** • Motor and compressor start up current.
- OHMS** • Continuity of wiring.
- Hz/FREQ** • Frequency on control and line voltages.
- REC** • Record min/max voltage of controls and line voltages.
- ALL** • Bar graph to indicate rapid fluctuations.

ELECTRICAL

- ACV** • Measure line voltage.
- ACA** • Measure line current.
- OHMS** • Continuity of circuit breakers.
- DCV** • Voltage of direct drive DC motors.
- ACA** • Start up current of motors, relays, contactors and transformers.

ELECTRONIC

- ACV** • Measure power supply voltage.
- ACA** • Measure power supply current.
- OHMS** • Continuity of circuit breakers and fuses.

8

3. Specifications

 **IEC 1010 Over Voltage:**
 CAT II - 1000V
 CAT III - 600V
 Pollution Degree 2



a. DCV

Range	Resolution	Accuracy	Impedance
40V	0.01V	±0.75% of reading,	10MΩ
400V	0.1V	±3 digits	
600V	1V		

b1. ACV (45Hz to 60Hz)

Range	Resolution	Accuracy	Impedance
40V	0.01V	±1.0% of reading,	10MΩ
400V	0.1V	±3 digits	
600V	1V		

b2. ACV (20Hz to 45Hz, 60Hz to 1KHz)

Range	Resolution	Accuracy	Impedance
40V	0.01V	±2.5% of reading,	10MΩ
400V	0.1V	±3 digits	
600V	1V		

 ***Warning:** Test Leads. Use only correct type and overvoltage category rating.

9

c. ACA			
Range	Res.	Accuracy	Freq. Response
40A	0.01A	±2% of reading, ±20 digits	45Hz to 60Hz
		±4% of reading, ±20 digits	30Hz to 45Hz
		±4% of reading, ±20 digits	60Hz to 1KHz
400A	0.1A	±2% of reading, ±10 digits	45Hz to 60Hz
700A	1A	±5% of reading, ±10 digits	30Hz to 45Hz
		±5% of reading, ±10 digits	60Hz to 1KHz

e. OHM (Resistance,)			
Range	Res.	Accuracy	Overload Protection
400	0.1	±1% of reading, ±10 digits	600V DC or
4k	0.001k	±1% of reading, ±3 digits	AC Peak
40k	0.01k		

f. Continuity Buzzer		
Test Voltage	Threshold	Over Load Protection
3V	< 100 (100 digits)	600 V DC or Peak AC

g. Diode Test		
Test Voltage	Max Test Current	Over Load Protection
3V	Approx. 2.5mA	600 V DC or Peak AC

 ***Warning:** Test Leads. Use only correct type and overvoltage category rating.

h. Frequency			
Range	Res.	Accuracy	Overload Protection
1KHz	0.1Hz	±0.2% of reading, ±3 digits	600V DC or
10KHz	0.001KHz		AC Peak

h. General Specifications	
Max. Volt. between any Input and Ground	600V
Display Type	4,000 Count, 4 times per second update
Operating Temp.	-10° to 45°C (14° to 113°F)
Storage Temp.	-20° to 55°C (-4° to 131°F)
Relative Humidity	0% to 80% (0° - 35°C/32° - 95°F) 0% to 70% (35° - 50°C/95° - 122°F)
Power Supply	9 Volt Battery
Battery Life	80 hrs. Alkaline
Size (H x L x W)	40mm x 190mm x 65mm (1.5in x 7.25in x 2.5in)
Weight	315g (11.1oz)

D. MEASUREMENT TECHNIQUES

1. Controls and Functions:

Push Buttons

TRIM	Activates TRIM, PEAK and HDR functions (Except on Frequency Range).
FUNC	Toggles between AC and DC volts, amps and Ω or \bullet functions.
RNG	Activates manual ranging. Hold in for 2 seconds to return to autorange.
HOLD	Holds the reading on the display until the button is pushed a second time.

1. Controls and Functions (cont.):

Rotary Switch

OFF	Turns the 293 completely off.
V	Used to measure AC and DC volts.
Ω \bullet	Used to measure resistance and use the continuity buzzer.
\rightarrow	Used to measure diodes.
FRQ	Used to measure the frequency of the current through the jaws.
A	Used to measure AC amps.
OFF	Turns the 293 completely off.

Input Jacks

COM	Black test lead connection for ACV, DCV, Ω , Continuity Buzzer and Diode Test functions.
V/Ω	Red test lead connection for all ACV, DCV, Ω , Continuity Buzzer and Diode Test functions.

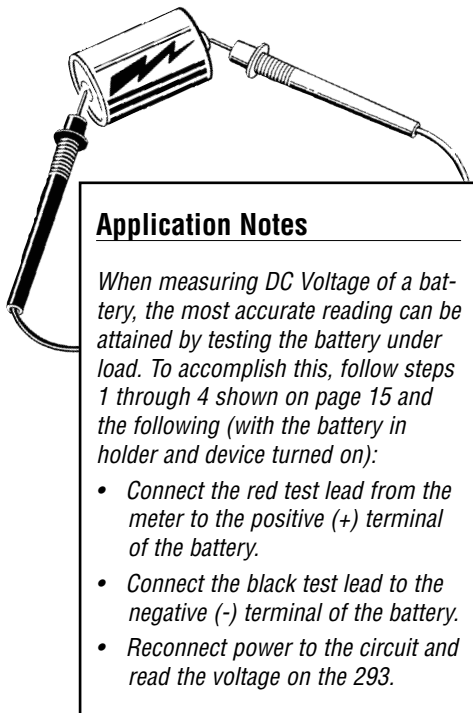

2. Step by Step Procedures:

a. Measuring DC Volts

⚠ WARNING!

Do not attempt to make a voltage measurement of more than 600V or of a voltage level that is unknown.

Instrument set-up:				
FUNC.	BLACK TEST LEAD	RED TEST LEAD	MIN READING	MAXI READING
\overline{V}	COM	V/ Ω	0.01V	600V

Measurement Procedure:

1. Disconnect power to circuit to be measured.
2. Plug black test lead into the **COM** input jack.
3. Plug red test lead into the \overline{V}/Ω input jack.
4. Set rotary switch to the \overline{V} range.
5. Push **FUNC** button so AC does not show on LCD.
6. Connect test leads to circuit to be measured.
7. Reconnect power to circuit to be measured.
8. Read the voltage on the 293.

Optional Modes

- **TRIM:** Push TRIM button to stabilize reading.
- **HOLD:** Freezes the reading on the LCD.
- **RANGE:** Manually ranges the instrument.

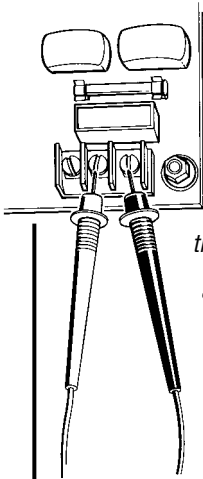

Application Notes

Disconnect power from the terminal block, find the fuse or circuit breaker that controls the block and turn it off.

Set up the meter following the steps under "Measurement Procedure" on page 17. Then proceed with the following:

- Connect the red test lead to the hot side of the block and the black lead to the neutral side of the block. Reconnect power to the block and read the voltage on the meter. The reading should be approximately 110V to 130V.
- Disconnect power from the block and move the red wire to ground. Reconnect power to the block and read the voltage on the meter. Typically less than 20V should exist from neutral to ground. If 110V or above exists, the block may be wired incorrectly.

b. Measuring AC Volts

⚠ WARNING!

Do not attempt to make a voltage measurement of more than 600V or of a voltage level that is unknown.

Instrument set-up:

FUNC.	BLACK TEST LEAD	RED TEST LEAD	MIN READING	MAX READING
\overline{V}	COM	V/ Ω	0.01V	600V

Measurement Procedure:

1. Disconnect power to circuit to be measured.
2. Plug black test lead into **COM** input jack.
3. Plug red test lead into **V/ Ω** input jack.
4. Set the rotary switch to the **V** function.
5. Press the **FUNC** button until AC is on LCD.
6. Connect test leads to circuit to be measured.
7. Reconnect power to circuit to be measured.
8. Read the voltage on the 293.

Optional Modes

- **TRIM:** Push **TRIM** button to stabilize reading.
- **HOLD:** Freezes the reading on the LCD.
- **RANGE:** Manually ranges the instrument.
- **PEAK:** Measures the peak voltage.

c. Measuring AC Amps

CAUTION!

Do not attempt to make a current measurement with the test leads. The 293 measures the current by clamping the jaw around one conductor (wire). Clamping around more than one wire will result in erroneous readings.

Instrument set-up:				
FUNC.	BLACK TEST LEAD	RED TEST LEAD	MIN READING	MAX READING
$\overline{\text{A}}$	NOT USED	NOT USED	0.01A	700A

Measurement Procedure:

1. Disconnect power to circuit to be measured.
2. Set rotary switch to $\overline{\text{A}}$ function.
3. Clamp the jaws around one conductor of the circuit to be measured.
4. Reconnect power to circuit to be measured.
5. Read the current on the 293.

Optional Modes

- **TRIM:** Push TRIM button to stabilize reading.
- **HOLD:** Freezes the reading on the LCD.
- **RANGE:** Manually ranges the instrument.
- **PEAK:** Measures the peak amperage.

Application Notes

When measuring AC Amps of a motor there are two types of measurements that can be made, running current and in-rush or start-up current. Start-up current will usually be much higher than running current.

Set up the meter following the steps under "Measurement Procedure" on page 20, and then proceed with the following:

- *Clamp the meter around a single wire and reconnect power to the device. Read the current displayed on the meter. This is the running current of the motor.*
- *Disconnect power to the motor and put the meter in PEAK HOLD mode. Reconnect the power and read the current displayed on the meter. This is the in-rush or start-up current of the motor.*

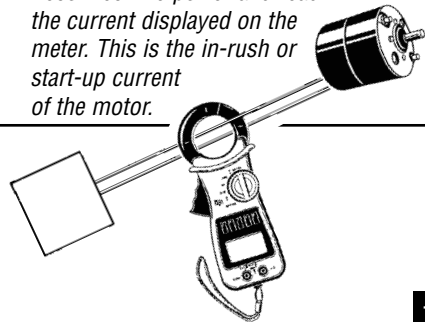

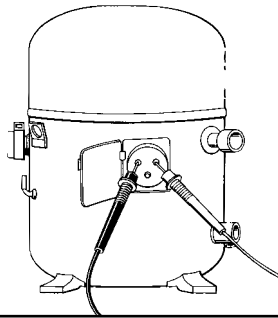

Application Notes (Resistance)

When measuring resistance of a motor, make sure the power is disconnected prior to testing.

Set up meter following steps under "Measurement Procedure" on page 20, and proceed with the following:

- Connect the red test lead to one power input line of the motor and the black test lead to the other power input line of the motor. In most applications if the reading is OFL, the motor winding is open.
- Connect the red test lead to the frame of the motor and the black test lead to the winding. In most applications if a reading of 0 Ohms is displayed, the winding is shorted to the motor frame (ground).

d. Measuring Resistance

⚠ WARNING!

Do not attempt to make resistance measurements with circuit energized. For best results, remove the resistor completely from circuit before attempting to measure it.

NOTE:

To make accurate low ohm measurements, short the ends of the test leads together and record the resistance reading. Deduct this value from actual readings.

Instrument set-up:

FUNC.	BLACK TEST LEAD	RED TEST LEAD	MIN READING	MAX READING
Ω ●	COM	V/ Ω	0.1 Ω	39.99K Ω

Measurement Procedure:

1. Disconnect power to circuit to be measured.
2. Plug black test lead into the COM input jack.
3. Plug red test lead into V/ Ω input jack.
4. Set the rotary switch to the Ω function.
5. Connect test leads to circuit to be measured.
6. Read the resistance value on the 293.

Optional Modes

- **HOLD:** Freezes the reading on the LCD.
- **RANGE:** Manually ranges the instrument.
- **TRIM:** Push TRIM button to stabilize reading.

e. Continuity Buzzer



WARNING!

Do not attempt to make continuity measurements with circuit energized.

Instrument set-up:

FUNC.	BLACK TEST LEAD	RED TEST LEAD	MIN READING	MAX READING
Ω 	COM	V/ Ω	0.001K Ω	4.000K Ω

Measurement Procedure:

1. Disconnect power to circuit to be measured.
2. Plug black test lead into the **COM** input jack.
3. Plug red test lead into **V/ Ω** input jack.
4. Set the rotary switch to the Ω  function.
5. Press the **FUNC** button until  is on the LCD.
6. Connect test leads to circuit to be measured.
7. Listen for the buzzer to confirm continuity.

Optional Modes

- **HOLD:** Freezes the reading on the LCD.
- **TRIM:** Push **TRIM** button to stabilize reading.

f. Measuring Diodes

CAUTION!

Do not attempt to make diode measurements with circuit energized. The only way to accurately test a diode is to remove it completely from the circuit before attempting to measure it.

Instrument set-up:

FUNC.	BLACK TEST LEAD	RED TEST LEAD	MIN READING	MAX READING
	COM	V/ Ω	0.001V	2.000V

Measurement Procedure:

1. Disconnect power to circuit to be measured.
2. Plug the black test lead into COM input jack.
3. Plug red test lead into the V/ Ω input jack.
4. Set the rotary switch to the  function.
5. Connect the black test lead to the banded end of the diode and the red test lead to the non-banded end of the diode.
6. Reading on the display should be between 0.5 and 0.8 volts.
7. Reverse test lead connections in 5 above.
8. Reading on the display should be OFL (Overload).

NOTE: If diode reads 0 in both directions, diode is shorted. If diode reads OFL in both directions, diode is open.

g. Measuring Frequency

CAUTION!

Do not attempt to make frequency measurements with test leads. The 293 measures the frequency by clamping the jaw around one conductor (wire). Clamping around more than one wire will result in erroneous readings.

Instrument set-up:				
FUNC	BLACK TEST LEAD	RED TEST LEAD	MIN READING	MAX READING
FREQ	NOT USED	NOT USED	0.5Hz	10KHz

Measurement Procedure:

1. Disconnect power to circuit to be measured.
2. Set the rotary switch to the **FREQ** function.
3. Clamp the jaws around one conductor of the circuit to be measured.
4. Reconnect power to circuit to be measured.
5. Read the frequency on the 293.

Note:

The current of the frequency being measured is displayed on the bar graph.

Optional Modes:

- **HOLD:** Freezes the reading on the LCD.
- **RANGE:** Manually ranges the instrument.

h. Data Hold

Press the **HOLD** button at any time on any function to freeze the reading on the LCD display. This function is very useful when measuring in locations where the display is difficult to read.

i. Trim

(Average sensing mode for ACV, ACA, OHM, Diode and Continuity.)

Press the **TRIM** button when measuring unstable signals to stabilize the reading. The 293 will average the measured value approximately every 1.25 seconds to obtain a clearer picture of the current or voltage being measured.

j. Peak Mode

1. Set the 293 to the **ACA** function.
2. Push the **RNG** button and select the desired measurement range.
3. Push the **TRIM** button until PEAK shows on LCD.
4. Allow the LCD to stabilize to zero.
5. Clamp the jaws around a single conductor to the device to be measured.
6. Apply power to the device under test.
7. Read the PEAK current on the LCD immediately after the test.

k. Disable Sleep Mode

1. Set the 293 to the **OFF** position.
2. Push and hold down the **HOLD** button while turning the rotary switch to the desired function.
3. Release the **HOLD** button.
4. Check the LCD to see if the HOLD function is activated. If “H” is on the display, push the **HOLD** button to deactivate the DATA HOLD mode.
5. Sleep mode is now deactivated.

E. ACCESSORIES*

Standard Accessories	Part No.
9 Volt Alkaline Battery	A009A
Test Lead Set	A040
Soft Carrying Pouch	A200

Optional Accessories	Part No.
Deluxe Test Lead Set	SDK1C
IEC 1010 Deluxe Test Lead Kit	TLS2000BC
Hard Carrying Case	A201

*These accessories have not been evaluated by UL and are not considered as part of the UL Listing of this product.

F. MAINTENANCE

1. **Battery Replacement:** The 293 will display a battery symbol when the internal 9 Volt battery needs replacement. The battery is replaced as follows:
 - a. Disconnect and remove all test leads from live circuits and from the 293.
 - b. Loosen the screw from the back of the 293 battery cover.
 - c. Remove the battery compartment cover.
 - d. Remove old battery and replace with new battery, observing the correct polarity.
 - e. Reassemble the instrument in reverse order from above.
2. **Cleaning your 293:**
Use a mild detergent and slightly damp cloth to clean the surfaces of the 293.

G. TROUBLE SHOOTING GUIDE

Problem

Probable Causes

Does not power up

- Dead or defective battery
- Broken wire from battery snap to PCB

Won't display current readings

- Open fuse
- Open test lead
- Improperly connected to circuit under test

All functions except ohms read high

- Very weak battery that will not turn on the low battery indicator on the LCD

AC Volts do not read

- Very weak battery that will not turn on the low battery indicator on the LCD

WARRANTY

Please refer to product warranty card for warranty statement.



Test Products International, Inc.

9615 SW Allen Blvd., Ste. 104
Beaverton, OR USA 97005
503-520-9197 • Fax: 503-520-1225
tpiusa@msn.com

Test Products International plc

2 Newcourt Business Park
Perry Road
Harlow, Essex CM18 7PR
England
Tel: 01279 439647 • Fax: 01279 450553

L293M • 12/1/97

copyright © 1997 Test Products International, Inc.

293 SPECIFICATIONS

±0.75% Basic DCV Accuracy (also see pages 9-11)

<u>Func.</u>	<u>Range</u>	<u>Res.</u>
DCV	40V	0.01V
	400V	0.1V
	600V	1V
ACV	40V	0.01V
	400V	0.1V
	600V	1V
ACA	40A	0.01A
	400A	0.1A
	700A	1A
OHM	400Ω	0.1Ω
	4kΩ	0.001kΩ
	40kΩ	0.01kΩ
Frequency	1KHz	0.1Hz
	10KHz	0.001KHz
Continuity	<u>Test Voltage</u>	<u>Max Test Current</u>
	3V	< 100Ω (100 digits)
Diode Test	<u>Test Voltage</u>	<u>Threshold</u>
	3V	Approx. 2.5mA

Test Products International, Inc.